

Roofing, Siding & Gutter Products

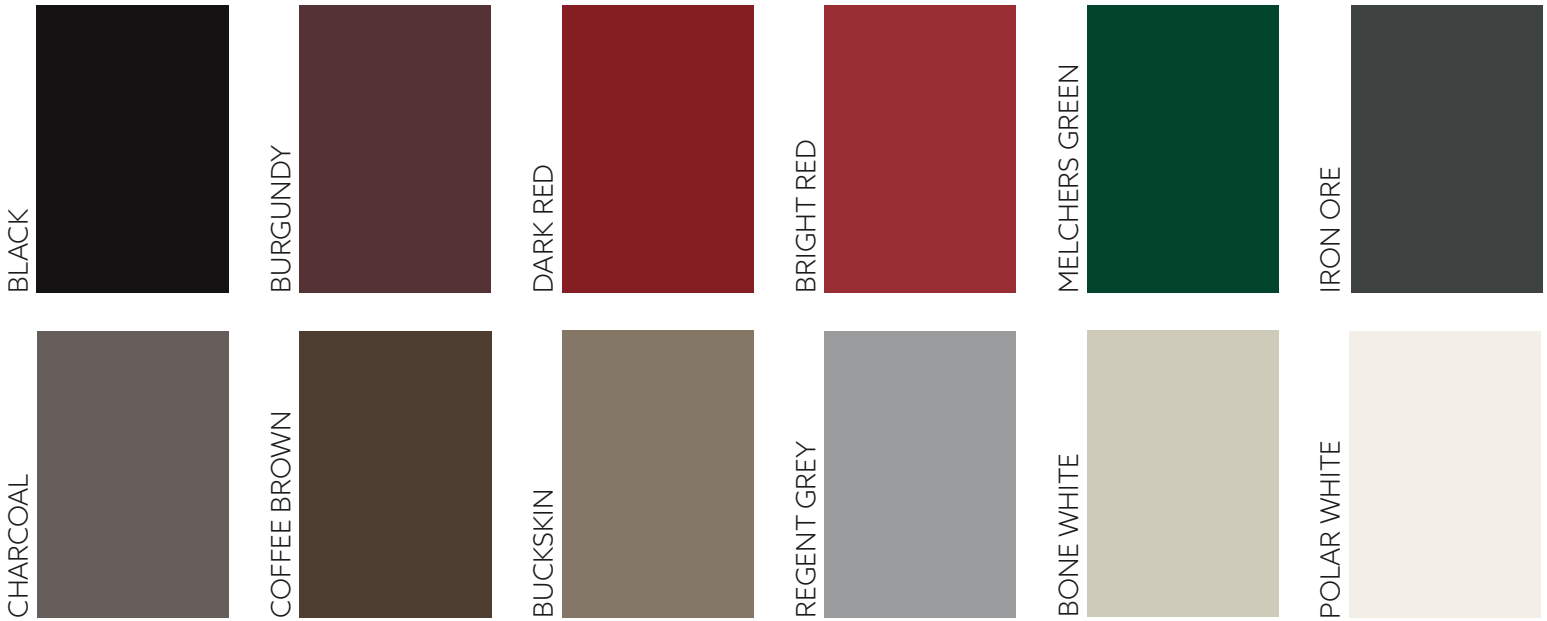

Standard Colours SMP (26 gauge)



PVDF Colours (24 gauge)



Custom colours, gauges, textures & wood grains available upon request

BML Metals - Trim options

All trims are sold in 10' lengths.

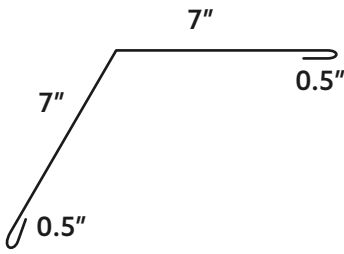

#401 - Ridge Cap

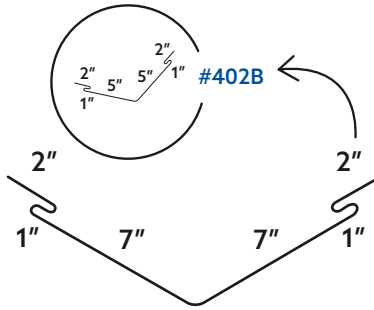

#402A - Hidden Fastener Valley

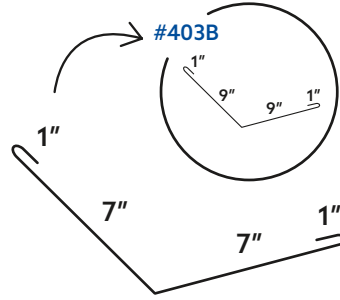

#403A - Valley

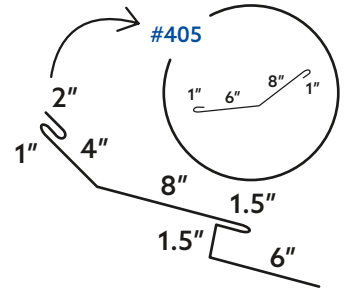

#404A - Hidden Fastener Transition

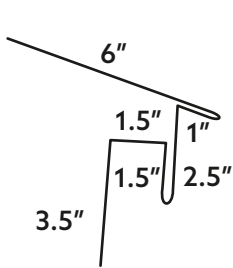

#406 - Hidden Fastener Upper Transition

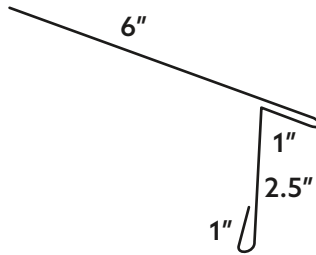

#407 - Upper Transition Drip Edge

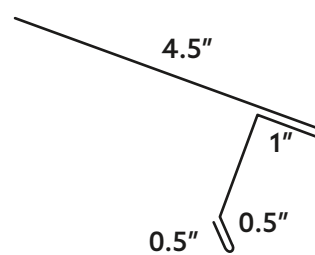

#408A - Roof Drip Edge

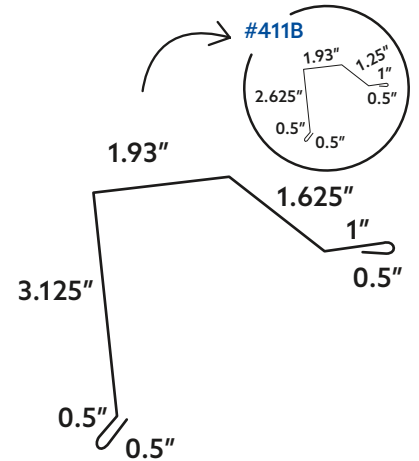

#411A - Exposed Gable

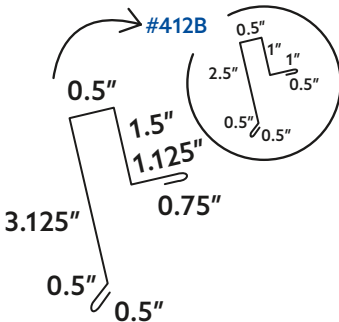

#412A - Exposed Gable

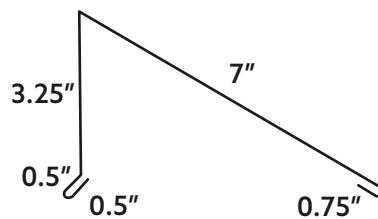

#414A - Half Ridge Cap

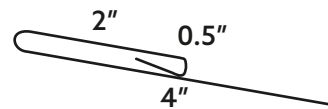

#415 - Gable Sill

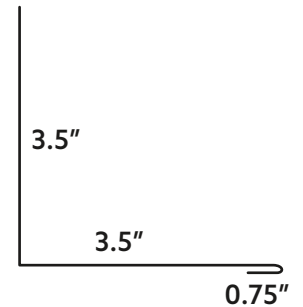

#416 - Sidewall

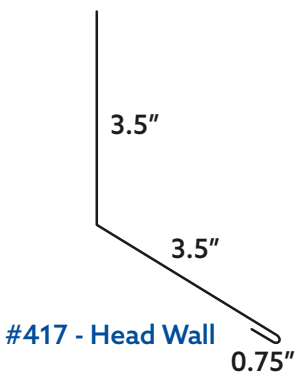

#417 - Head Wall

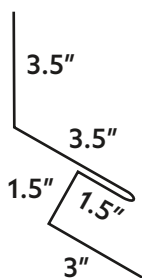

#418 - Head Wall with J Trim

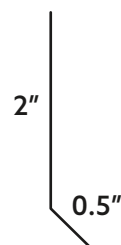

#419 - L-Clip

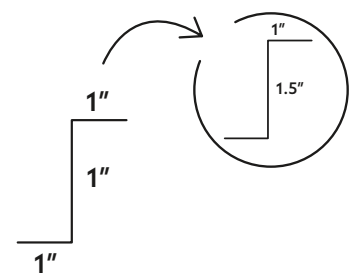

#420 - Z Bar